

**READ AND SAVE THESE INSTRUCTIONS  
LIRE ET CONSERVER CES INSTRUCTIONS**

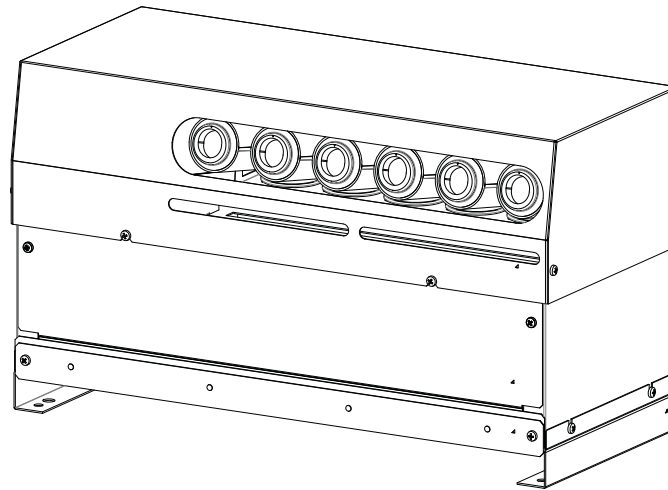

Retrofit & Conditioning

Humidification

# STULZ DRH Series GEN2

## Energy Efficient Ultrasonic Humidifier

**Models:**

**DRH-04**

**DRH-08**

**DRH-06**

**DRH-16**

**IOM** Installation, Operation & Maintenance

**STULZ**<sup>®</sup>

# MODEL NOMENCLATURE

## DRH- 04- S

**DRH = Direct Room Humidifier**  
DAH = Ducted Air Humidifier

(Blank) = Ultra-Series Control

**S = Stand Alone**

**04 = Number of Transducers**

06

08

16

### Notice

This document contains information protected by copyright. All rights are reserved. The owner of the equipment for which this manual is written may photocopy the contents of this manual for internal use only. No part of this document may be photocopied, reproduced, or translated into another language for use by anyone other than the owner of the equipment for which this manual is written without the prior written consent of Stulz Air Technology Systems, Inc. (STULZ).

This document contains confidential and proprietary information of Stulz Air Technology Systems, Inc. Distributing or photocopying this document for external distribution is in direct violation of U.S. copyright laws and is strictly prohibited without the express written consent of STULZ.

Unpublished — rights reserved under the copyright laws of the United States and of other countries. Other brands and tradenames are trademarks of their respective owners.

Copyright 2013 by Stulz Air Technology Systems, Inc.  
Printed in the United States of America.  
All rights reserved.

**Stulz Air Technology Systems, Inc.**  
**1572 Tilco Drive**  
**Frederick, MD 21704**  
**USA**

# TABLE OF CONTENTS

<b>1.0</b>	<b>Introduction .....</b>	<b>1-1</b>	4.2.1	Air Filter.....	4-3
1.1	General .....	1-1	4.2.2	Water Supply Strainer/Flow Regulator.....	4-3
1.2	Safety.....	1-1	4.2.3	Electrical Parts .....	4-3
1.2.1	General .....	1-1	4.2.4	Float Switches.....	4-4
1.2.2	Safety Summary .....	1-1	4.2.5	Water Tank.....	4-5
1.3	Product Warranty .....	1-3	4.2.6	Mist Guides .....	4-5
1.4	Specifications.....	1-4	4.3	Troubleshooting and Repair.....	4-6
1.5	General Design.....	1-5	4.4	General Common Repairs/Parts Replacement.....	4-8
1.6	Main Parts.....	1-5	4.4.1	Preparation For Repairs.....	4-8
1.6.1	Ultrasonic Nebulizer Unit .....	1-5	4.4.2	Reassembling .....	4-8
1.6.2	Mist Guide.....	1-5	4.4.3	Replacing the Temperature Sensor .....	4-9
1.6.3	High Water Float Switch .....	1-5	4.4.4	Replacing a Transducer .....	4-10
1.6.4	Low Water Float Switch .....	1-5	4.4.5	Replacing a Nebulizer Print Plate .....	4-11
1.6.5	Fan .....	1-5	4.4.6	Water Solenoid Valves, Float Switches and Level Control Board .....	4-11
1.6.6	Air Filter.....	1-5	<b>5.0</b>	<b>Product Support Group .....</b>	<b>5-1</b>
1.6.7	Water Fill Valve Solenoid .....	1-5	5.1	Technical Support .....	5-1
1.6.8	Water Supply Valve.....	1-5	5.2	Obtaining Warranty Parts.....	5-1
1.6.9	Water Supply Tubing.....	1-5	5.3	Obtaining Spare/Replacement Parts .....	5-1
1.6.10	Drain and Overflow Assembly.....	1-5	<b>6.0</b>	<b>Drawings .....</b>	<b>6-1</b>
1.6.11	Temperature Sensor .....	1-5	6.1	Layout Drawing of Humidifier.....	6-1
1.6.12	Solid State relay.....	1-6	6.2	Electrical Circuit Diagrams.....	6-2
1.6.13	Level Controller.....	1-6			
<b>2.0</b>	<b>Installation .....</b>	<b>2-1</b>			
2.1	Receiving the Equipment.....	2-1			
2.2	Site Preparation .....	2-1			
2.3	Mounting/Placement .....	2-2			
2.4	Supply and Drain Piping .....	2-2			
2.5	Main Power/Control Wiring .....	2-3			
<b>3.0</b>	<b>Operation .....</b>	<b>3-1</b>			
3.1	Purge the Water Supply Line .....	3-1			
3.2	Initial Operation Checklist .....	3-1			
3.3	Procedure For Operation .....	3-1			
3.4	Precautions.....	3-2			
3.5	Steps for Long Term Shutdown.....	3-2			
<b>4.0</b>	<b>Maintenance/Repairs .....</b>	<b>4-1</b>			
4.1	Periodic General Maintenance.....	4-1			
4.1.1	General .....	4-1			
4.2	Maintenance Items and Necessary Tools ..	4-2			

## List of Figures

Figure 1-	Installation of Humidifier .....	2-1
Figure 2-	Locating the Humidifier .....	2-2
Figure 3-	Piping Connections.....	2-3
Figure 4-	Water Inlet Filter Strainer Connector .....	2-3
Figure 5-	Electrical Connections .....	2-4

## 1.0 INTRODUCTION

### 1.1 General

Recognized as a world leader, Stulz Air Technology Systems, Inc. (STULZ) Ultrasonic Humidifiers are designed and manufactured with the highest quality craftsmanship using the finest materials available in the industry. Your ultrasonic humidification system will provide years of trouble free service if installed and maintained in accordance with this manual. Damage to the unit from improper installation, operation or maintenance is not covered by the warranty.

This manual contains information for installation, operation, maintenance, troubleshooting and repair. **STUDY** the instructions contained in this manual. They must be followed to avoid difficulties. Spare parts are available from STULZ to ensure continuous operation. Using substitute parts or bypassing electrical components in order to continue operation is not recommended and will **VOID THE WARRANTY**. Due to technological advancements, components are subject to change without notice.

STULZ *DRH Series* Ultrasonic Humidifiers are designed as stand alone direct room humidifiers. Any use beyond this is deemed to be not intended. STULZ is not liable for any damage resulting from improper use. The system is designed to be installed indoors unless otherwise noted on the equipment nameplate.

### 1.2 Safety

#### 1.2.1 General

Stulz Air Technology Systems, Inc. uses **NOTES** along with **CAUTION** and **WARNING** symbols throughout this manual to draw your attention to important operational and safety information.

A bold text **NOTE** marks a short message in the information to alert you to an important detail.

A bold text **CAUTION** safety alert appears with information that is important for protecting your equipment and performance. Be especially careful to read and follow all cautions that apply to your application.

A bold text **WARNING** safety alert appears with information that is important for protecting you from harm and the equipment from damage. Pay very close attention to all warnings that apply to your application.

A safety alert symbol  accompanies a general **WARNING** or **CAUTION** safety statement.

A safety alert symbol  accompanies an electrical shock hazard **WARNING** or **CAUTION** safety statement.

#### 1.2.2 Safety Summary

The following statements are general guidelines followed by warnings and cautions applicable throughout the manual.

Prior to performing any installation, operation, maintenance or troubleshooting procedure read and understand all instructions, recommendations and guidelines contained within this manual.

#### **WARNING**

**High voltage is used in the operation of this equipment. Death on contact may result if personnel fail to observe safety precautions.**

#### **CAUTION**

This unit must be installed according to local and national electric codes.

#### **CAUTION**

All maintenance and/or repairs must be performed by a qualified technician. All personnel working on or near equipment should be familiar with hazards associated with electrical maintenance.

#### **CAUTION**

Always turn off the main power and unplug the unit before beginning work on the equipment.

#### **NOTE**

Wiring terminations may become loose during transit of the equipment therefore; verify all wiring terminations are secure prior to operation.

#### **NOTE**

Do not attempt to make repairs without the proper tools.

## **NOTE**

STULZ offers no warranty protection on humidification systems using controls that are not provided by STULZ.

## **CAUTION**

It is essential that De-ionized (DI) or Reverse Osmosis (RO) water be used as the supply water source to maintain full warranty coverage. The use of untreated water will VOID THE WARRANTY.

## **CAUTION**

Use only non-corrosive stainless steel or poly tubing rated for use with DI water to supply the humidifier.

## **CAUTION**

Provide a drain with an air gap per local and national plumbing codes.

## **CAUTION**

Never block the mist outlet or the opening of the air inlet. The humidifier may be filled with the condensed mist and electrical shorts may result.

## **CAUTION**

Observe the unit for water leakage. A short circuit could occur if the humidifier is splashed with water while operating.

## **CAUTION**

Never attempt to remove the mist guide cover and/or the mist blow tubes while the humidifier is operating, or electrical shorts may result.

## **CAUTION**

If there is a risk of supply water freezing, pipe insulation should be provided.

## **CAUTION**

Never apply power when the humidifier is overturned or upside down. Damage to the ultrasonic nebulizer unit or transducer may result.

## **CAUTION**

Never drop the humidifier or apply hard shock to it. It may damage internal parts.

## **CAUTION**

Drain the water in the tank for sanitary reasons when humidifier is turned is off for more than 3 days.



Ultrasonic Humidifier- Model DRH-06

### 1.3 Product Warranty

STULZ offers a standard two year limited warranty as stated below:

#### **2-Year Standard Limited Warranty:**

Stulz Air Technology Systems, Inc., warrants to the original buyer of its products that the goods are free from defects in material and workmanship. Stulz Air Technology Systems, Inc.'s obligation under this warranty is to repair or replace, at its option, free of charge to the customer, any part or parts which are determined by Stulz Air Technology Systems Inc. to be defective for a period of 24 months from date of shipment when a completed start-up form has been submitted to Stulz Air Technology Systems, Inc. within 90 days from shipment. In the event that a completed start-up form is not received by Stulz Air Technology Systems, Inc. within 90 days from shipment, the company's obligation will be for a period of 12 months from date of shipment. Parts repaired or replaced under this warranty are shipped FOB Factory, and warranted for the balance of the original warranty period or for 90 days from the date of installation, whichever is greater.

Stulz Air Technology Systems, Inc.'s warranty does not cover failures caused by improper installation, abuse, misuse, misapplication, improper or lack of maintenance, negligence, accident, normal deterioration (including wear and tear), or the use of improper parts or improper repair.

Purchaser's remedies are limited to replacement or repair of non-conforming materials in accordance with the written warranty. This warranty does not include costs for transportation, costs for removal or reinstallation of equipment or labor for repairs or replacement made in the field.

If any sample was shown to the buyer, such sample was used merely to illustrate the general type and quality of the product, and not to represent that the equipment would necessarily conform to the sample.

This is the only warranty given by the seller, and such warranty is only given to buyers for commercial or industrial purposes. This warranty is not enforceable until the invoice(s) is paid in full.

THE FOREGOING SHALL CONSTITUTE STULZ'S ENTIRE LIABILITY AND YOUR EXCLUSIVE REMEDY. IN NO EVENT SHALL STULZ BE LIABLE FOR ANY DIRECT, INDIRECT, SPECIAL, INCIDENTAL, CONSEQUENTIAL, OR EXEMPLARY DAMAGES, INCLUDING LOST PROFITS (EVEN IF ADVISED OF THE POSSIBILITY THEREOF) ARISING IN ANY WAY OUT OF THE INSTALLATION, USE OR MAINTENANCE OF THE EQUIPMENT. THIS WARRANTY IS IN LIEU OF ALL OTHER WARRANTIES, EXPRESS OR IMPLIED, INCLUDING WARRANTIES OF MERCHANTABILITY OR FITNESS FOR A PARTICULAR PURPOSE.

#### **Conditions for Maintaining Warranty Coverage:**

- 1) De-ionized (DI) or Reverse Osmosis (RO) water is used as the supply water for the humidifier.
- 2) STULZ provided controls are used with the humidification system.
- 3) Input voltage to the humidifier does not exceed 51VDC.

## 1.4 Specifications

Type	DRH Series Ultrasonic Humidifier			
Model	DRH-04	DRH-06	DRH-08	DRH-16
Nebulizing capacity (lb/h)	4.4	6.6	8.8	17.6
Qty. of Ultrasonic nebulizers/unit	4	6	8	16
Power source	48VDC			
Rated power consumption (W)	134	195	256	505
Weight (lb)	19.8	24.3	30.9	50.7
<b>Electrical Characteristics</b>				
Allowable voltage range	47-51VDC			
Insulation resistance	100 M.Ohms or more (excluding solid-state components).			
Dielectric voltage withstand	Operational when 1500VAC is applied for 1 minute (excluding solid-state components).			
<b>Operating conditions</b>				
Ambient working conditions	34 to 122°F; 90%RH or less.			
Water supply quality	DI or RO water. Water conductance <5 microsiemens purity.			
Water supply pressure	30 to 75 psi			
Water supply temperature	40°F to 104°F			
<b>Parts to be provided by user:</b>				
DI or RO supply water, Water supply valve, Water supply tubing (1/4" stainless steel or poly tubing rated for DI water), power supply wiring and control wiring to the control box.				

- Notes:
- 1) Calcium, magnesium or other agents that may be contained in the supply water are atomized into the air together with the mist and may form white powders after the water has evaporated. To avoid this, always use DI or RO supply water.
  - 2) The nebulizing capacity of the transducer in the ultrasonic nebulizer unit decreases gradually with use. It should usually be exchanged after about 10,000 to 15,000 hours of operation, (depending on water quality and suitable voltage), although the unit may continue to run as long as it's effective capacity meets the particular requirements.
  - 3) To ensure full warranty coverage, the input voltage to the humidifier must not exceed 51VDC. If the input voltage exceeds 51VDC, damage to the transducers and print plates will result.

## **1.5 General Design**

The *DRH* Ultrasonic Humidifier directly atomizes water, producing a fine mist. The humidifier incorporates high frequency nebulizers to produce ultrasonic waves, a fan to propel the mist out, and an automatic water supply mechanism to maintain the supply water at a constant level. When conducting routine maintenance, it is important to clean the air filter and water tank because it significantly affects the humidifying capacity and life of the ultrasonic nebulizers.

## **1.6 Main Parts**

### **1.6.1 Ultrasonic Nebulizer Unit**

This consists of a modular assembly located in the bottom of the water tank incorporating a 1.6 Mhz power oscillator on and a piezoelectric transducer. The transducer vibrates at that frequency, developing ultrasonic columnar waves in the water and producing a fine mist above that column.

### **1.6.2 Mist Guide**

The mist guide carries the mist off the top of the columnar wave and directs it up and out of the humidifier.

### **1.6.3 High Water Float Switch**

For maximum atomization, it is essential the water level in the tank be constantly maintained. The High Water Float Switch is an input to the Level Controller. It is open when the water level is below the optimal level and is closed when the water level reaches the maximum level.

### **1.6.4 Low Water Float Switch**

Operating the humidifier when the water level is below the top of the transducers will damage the Ultrasonic Nebulizer Unit. The Low Water Float Switch is an input to the Level Controller. It is open when the water level is near an unsafe level and is closed when the water level is at a minimal level.

### **1.6.5 Fan**

The 24VDC fan or fans both lightly pressurizes the air above the water to provide a path for the mist to pass through the Mist Tubes and provides a sheet of air to carry the mist away from the humidifier into the room. The fan is controlled by the Level Controller.

### **1.6.6 Air Filter**

The Air Filter removes coarse dust from the air and prevents the humidifier water tank from becoming dirty which would affect the mist output.

### **1.6.7 Water Fill Valve Solenoid**

The Water Fill Valve Solenoid is a 24VDC solenoid that allows water from the water supply to enter into the tank when energized by the Level Controller. There is an orifice to restrict the flow of water.

### **1.6.8 Water Supply Valve**

(To be provided by the user)

A valve must be installed upstream from the humidifier for service and maintenance. The valve must be rated for use with DI water.

### **1.6.9 Water Supply Tubing**

(To be provided by the user)

Water supply tubing must be provided to connect the water supply to the water strainer/flow regulator on the end of the unit. The strainer/flow regulator is equipped with a 90° swiveling, ¼" push-to-connect fitting. Utilize ¼" stainless steel or poly tubing rated for use with DI water.

### **1.6.10 Drain and Overflow Assembly**

The Drain and Overflow Assembly contains a 24VDC drain solenoid valve, an overflow pipe and a drain outlet. The drain valve solenoid is controlled by the Level Controller to drain water from the tank via the drain outlet. If the water level in the tank exceeds the height of the overflow pipe, the excess water is diverted to the drain outlet. The drain outlet pipe is 1/8" MPT and ships with a stainless steel cap.

### **1.6.11 Temperature Sensor**

The temperature sensor monitors the temperature of the tank and is read by the Level Controller which prevents overheating and freeze protection

### **1.6.12 Solid State Relay**

The 48VDC operating voltage for the Ultrasonic Nebulizer Units is switched on and off by a solid state DC relay controlled by the Level Controller.



## 1.6.13 Level Controller

The Level Controller is a microprocessor based device located in the electric box that receives inputs from sensors and other inputs and in turn controls the valves, fan and Ultrasonic Nebulizer Units. It consists of a DC-DC power supply to convert the 48VDC to 24VDC for the fans and solenoids and a further reduction to 5VDC for the microprocessor, sensors, power switches and either a Modbus interface to communicate with the Ultra-Series Control box or a simple standalone input interface depending on which model humidifier was purchased. The 48VDC must be present at all times to allow the Level Controller microprocessor to monitor the inputs and control the outputs.

The microprocessor monitors the on/off command from either the Modbus or the input dry contact (depending on which model was purchased). If commanded on, the microprocessor checks the Low Water Float Switch and the High Water Float Switch. If the water is too low, the microprocessor turns on the Water Fill Valve Solenoid and monitors the Float Switches. When the water level is above the low water level, the fan is turned on. When the water level is above the high water level, the Water Fill Valve Solenoid is turned off and the Solid State Relay is turned on. When the water level falls below the high water level, the microprocessor turns the Water Fill Valve Solenoid on again to maintain optimal water level. When the on/off command is removed, the Solid State Relay is turned off and, after a few seconds time delay to eliminate the remaining mist from the humidifier, the Fan is turned off.

Proportional control is accomplished by the microprocessor monitoring the proportional signal from the Modbus or proportional input (depending on which model was purchased). When the proportional signal is greater than 10% of the maximum input, the microprocessor will turn the Solid State Relay on and off in a pulse-width modulation control. The period of the pulse width is 1 second. For 10% control, the Solid State Relay is turned on for 0.1 second and off for 0.9 second. The on time increases as the input approaches 100%. At 100%, the Solid State Relay is on continuously.

Safety control is built into the microprocessor. The voltage applied to the transducer affects the amount of mist produced. Too high a voltage can cause damage to the transducer and too low a voltage

prevents mist from being formed. The microprocessor monitors the 48VDC to be within a range of voltages. If the voltage is out of range, the microprocessor will not energize the Solid State Relay.

If the temperature of the tank rises too high, the microprocessor turns off the Solid State Relay. If the temperature approaches freezing, the microprocessor turns off the Solid State Relay and the fan, and then drains the tank to prevent damage from freezing water. When the temperature returns to a safe level, normal operation is resumed.

A low level alarm is annunciated when the microprocessor sees the Low Level Float Switch indicate low water after the tank has been filled. A fill alarm is annunciated when the High Water Float Switch does not indicate the water level has been achieved after a predetermined amount of time. A transducer alarm is annunciated if the transducers have been energized and no water is used in a predetermined time (indicating no transducer is functioning). For the Modbus version of the Level Controller, failure to receive commands on the Modbus within a predetermined amount of time will annunciate a communications alarm.

The Level Controller has an LED that displays, via blinking, any alarm condition that occurred after power up. Each alarm is associated with a number of blinks, followed by a pause, and then the next alarm is displayed. To view the LED, the Mist Guide Cover must be removed and the electrical access cover removed. The LED blink pattern for each alarm is:

Number of Blinks	Alarm Condition
1	Low Voltage
2	High Voltage
3	Freeze
4	High Temperature
5	Low Water
6	Fill Alarm
7	Communications
8	Transducer

## 2.0 INSTALLATION

### 2.1 Receiving the Equipment

Your Ultrasonic humidifier has been tested and inspected prior to shipment. To ensure that your equipment has been received in excellent condition, make a visual inspection of the equipment immediately upon delivery. Carefully remove the shipping container and all protective packaging. Open the box and thoroughly inspect the unit for any signs of transit-incurred damage. If there is shipping damage, it must be noted on the freight carrier's delivery forms **BEFORE** signing for the equipment. Any freight claims **MUST** be done through the freight carrier. STULZ ships all equipment FOB factory. STULZ is not liable for any equipment damage while in transit. STULZ can assist in the claim filing process with the freight carrier. Should any such damage be present, notify the STULZ Product Support Group prior to attempting any repairs. Refer to Section 5.0 of this manual for instructions.

Check the equipment against the packing slip to see if the shipment is complete. Report all discrepancies to the appropriate authority.

Contents of Package:

1. Humidifier
2. Six foot long power cable with moisture-proof, twist-lock connector on one end.
3. Installation, Operation and Maintenance manual.

Avoid dropping or jarring the unit to prevent damage to the internal parts. The unit should always be stored in a dry location prior to installation.

A Data Package has been sent with your unit. It contains this manual, system drawings, applicable MSDS's and other applicable instructions based on the configuration and options selected for your unit. The data package has been placed in your unit in a clear plastic bag. These documents need to be kept with the unit for future reference.

### 2.2 Site Preparation

STULZ ultrasonic humidifiers are designed with easy service access in mind. Install the unit in a secure location where it cannot be tampered with and the power switch cannot be inadvertently turned off. Allow access to the unit for routine operation, servicing and for necessary maintenance. Position the humidifier in such a way that the unit can be easily removed for future inspection and maintenance. Refer to the installation drawing provided with your unit for the dimensions of the humidifier.

#### NOTE

Working clearance requirements need to be established prior to mounting the unit. Refer to local and national electrical codes.

When selecting the installation location, attention should be paid to the air flow in the room so that the atomized mist can be uniformly diffused throughout the room. If any obstacle exists in front of the atomized mist outlet, the mist will be condensed on the obstacle to form water droplets.

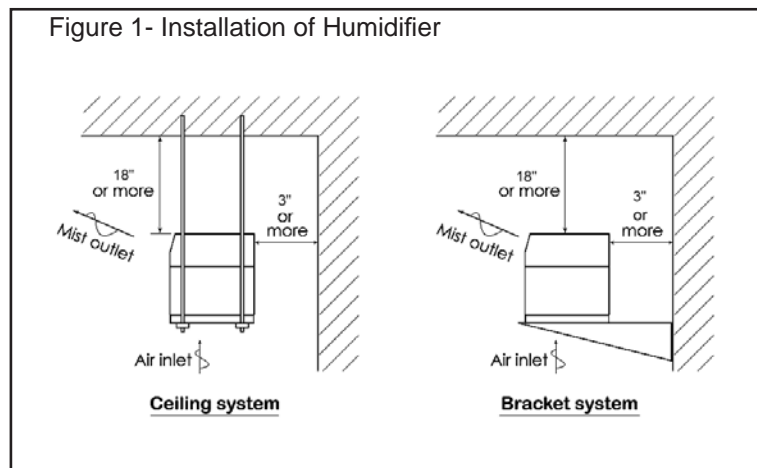

The humidifier must be installed horizontally and level to prevent the float switches from giving a false reading. Prepare hanging bolts for installing from the ceiling or brackets for wall mounting (see Figure 1). The distance from the humidifier to the ceiling should be a minimum of 18" and the distance to the wall must be 3" or more. For the installation mounting base dimensions, see the installation drawing provided with your unit.

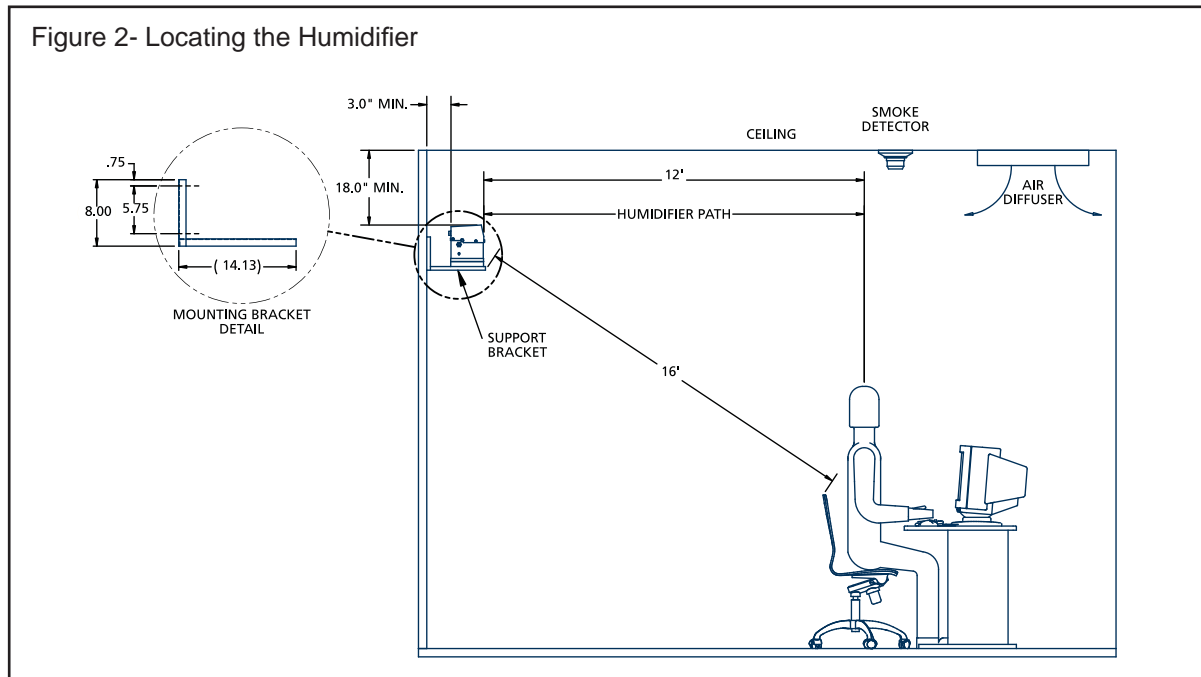

## NOTE

Humidity control can only be achieved in a sealed room or if the room has vapor barriers installed. It is recommended that walls, ceilings and floors be sealed to prevent migration of humidity.

## 2.3 Mounting/Placement

STULZ ultrasonic humidifiers are designed for mounting to a flat surface. Ensure the base is capable of supporting the weight of the unit. Weight estimates can be found on the installation drawing provided with your unit. Secure the unit with fasteners (field supplied by others), so that it will not move during operation. Ensure the front edge of the humidifier is not hanging over the edge of the support bracket.

## 2.4 Supply and Drain Piping

The humidifier will require a field installed water supply line and drain line. Refer to the piping diagram provided with your unit for details. For the water supply, use DI or RO water. The water supply to the humidifier cannot be taken directly from the public water service. Untreated supply water will leave a residue in the conditioned space where "white powder" is produced after evaporation from the calcium or magnesium which is dissolved in the water. In cases where water quality, especially "residue from evaporation", "pH", "total hardness" and "water conductivity" exceeds or is outside the range of standard, routine maintenance intervals to ensure continuous operation will be more frequent than usual. Also, the operating life of the transducers and print plates will be significantly reduced.

## CAUTION

It is essential that DI or RO water be used as the supply water source to maintain warranty coverage. The use of untreated water will VOID THE WARRANTY.

## NOTE

The water supply piping must be non-corrosive stainless steel or poly tubing rated for use with de-ionized water.

Prepare the water supply piping. The water supply piping should be equipped with a water supply valve for maintenance purposes (user provided) at a place as close as possible to the humidifier. The valve must be rated for use with DI water. After the water supply valve is installed, flushing should be done by supplying water (see Section 3.1, "Purge the Water Line"). This is a necessary step to prevent chips and oil in the piping from entering the humidifier.

The strainer/flow regulator is equipped with a 90° swivel, 1/4" push-to-connect, fitting (see Figure 4). Connect the water supply piping to the humidifier by means of a 1/4" stainless steel or poly tubing (user provided). If there is a risk that the water supply piping could freeze, wrap the piping with insulating material.

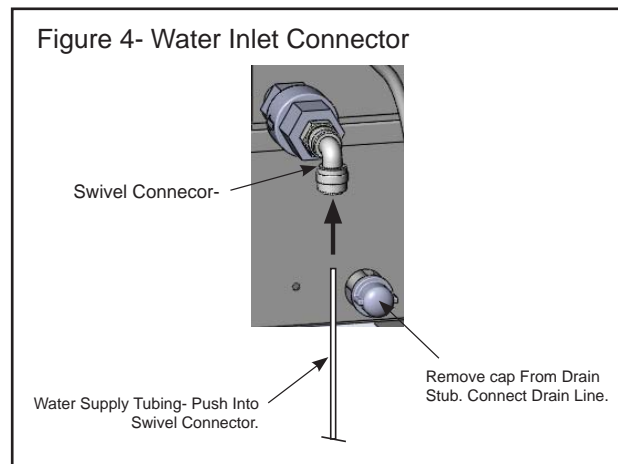
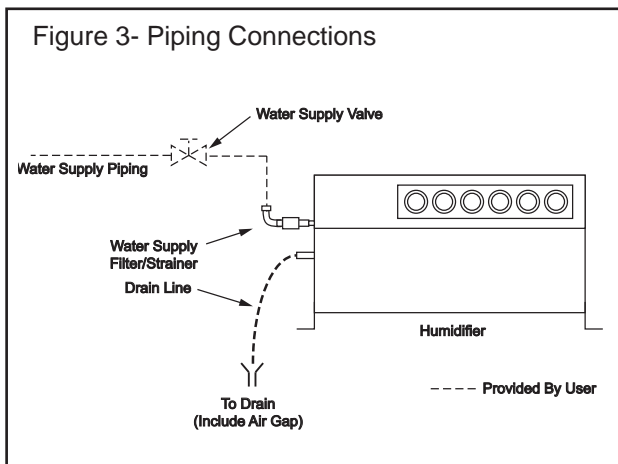

A drain line rated for use with DI water must be provided from the 1/8" MPT water tank drain stub in the side of the unit. Connect the drain line to the stub so that overflowing water can be directed into a drain pan or an appropriate place such as an open building drain with an air gap per local and national plumbing codes. The drain line must meet local and national plumbing codes, be sloped downward and away from the humidifier, include an air gap, and the end should not be obstructed.

## 2.5 Main Power And Control Wiring

**For wiring, refer to the electrical drawing supplied with your unit to determine the total number of interconnecting conductors required for your system and for the proper wire terminations.**

For internal wiring of the humidifier, see the "Electrical Circuit Diagrams", Section 6.2.

### NOTE

Wiring terminations may become loose during transit of the equipment therefore, verify all wiring terminations are secure prior to operation.

Verify that the main power supply to the control box coincides with the voltage, phase and frequency information specified on the nameplate. The nameplate also provides the full load amps (FLA), the current that the unit will draw under full design load, the minimum circuit ampacity (MCA) for wire sizing, and the maximum fuse size (MFS) for circuit protection. The power source must be provided with a circuit breaker for safety. Ensure a ground is connected to the unit. The humidifier is rated to operate with a nominal input of 48VDC. To maintain warranty coverage, never allow the humidifier input voltage to exceed 51 volts as damage will occur to the transducers and print plates.

## 2.5.1 Wire Sizing Control Box to Humidifiers

The table below indicates the correct electrical wire sizing from the control box to the humidifier power cable for three different distances. All wire sizes listed are for stranded, THHN or NTW wire only. Do not use solid conductor wire. For distances over 75 feet please consult the factory.

In addition to the above power wires, humidifiers controlled by the Ultra-Series control box utilize RJ45/CAT5 data communication cables, daisy chained from the humidifier(s) to the control box. The data communication cable is not to exceed 1000 feet total length from the control box to the last humidifier. A termination resistor must be installed on the last humidifier as shown in the electrical drawing provided with your unit.

### CAUTION

The termination resistor is to be placed only on the last unit in the data communication string.

### CAUTION

It is important to note that the power supply provided with the equipment is sized and selected based upon the expected load. Do not connect any additional loads to the control power supply.

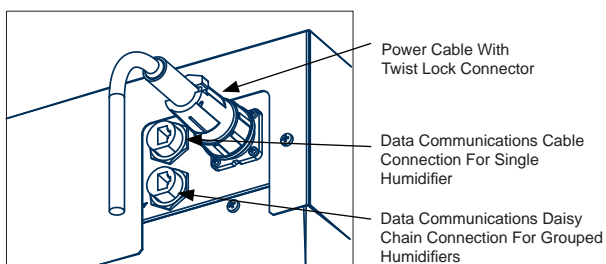

Figure 5- Electrical Connections

## 2.5.2 Connecting Humidifier(s) to Control Box

As a standard, STULZ GEN2 Ultrasonic humidifiers are equipped with a twist lock power connector and (2) RJ45 ports for data communication. The Ultrasonic Control box will also be equipped with an RJ45 port for data communication. The DRH Series Ultrasonic Humidifiers are designed for stand-alone direct room applications. A 6 foot power cable with a moisture-proof, twist-lock connector on one end is provided with each humidifier.

### 2.5.2.1 Single Humidifier

Once the humidifier and control box are installed, the total 48VDC wire length and wire size (AWG) should be determined using the table below. A junction box (not provided) is necessary to make the connection between the field-installed 48VDC power wiring and the factory provided humidifier power cable.

RJ45/CAT5 cable (not included) should be used in required length(s) to make the data communications connection between the humidifier and the control box. The factory provided end-of-line termination resistor should be installed in the second RJ45 port.

### 2.5.2.2 Multiple Humidifiers (Grouped)

Once the humidifiers and control box are installed, the total 48VDC wire length and wire size (AWG) should be determined using the table below for each humidifier. A junction box (not provided) is necessary to make the connection between the field-installed 48VDC power wiring and the factory provided humidifier power cable.

RJ45/CAT5 cable (not included) should be used in required length(s) to make the data communications connection between the humidifier and the control box. Additional RJ45 cables (not included) should be used in required lengths to make the data communications connections between humidifiers in the group. The factory provided end-of-line termination resistor should be installed in the second RJ45 port of the last humidifier.

48VDC WIRE SIZING FROM CONTROL BOX TO HUMIDIFIERS					
MODEL	CURRENT (AMPS)	WIRE SIZE (AWG)			# OF WIRES (Includes 1 Ground)
		25 Ft	50 Ft	75 Ft	
DRH-04	2.8	16	16	14	3
DRH-06	4.0	16	16	14	3
DRH-08	5.3	16	14	12	3
DRH-16	10.5	16	14	12	3

\*NOTE: Table reflects correct electrical wire sizing from the control box to the humidifiers. Do not exceed 75 ft. maximum distance.

## **3.0 OPERATION**

### **3.1 Purge the Water Line**

Before operating the unit, metal shavings or debris that may form during the installation process must be flushed from the water supply piping. Perform the following steps before allowing water to flow into the humidifier:

1. Ensure the main disconnect switch from the control box is set to "Off" for safety.
2. With the water supply valve closed, disconnect the supply tubing from the filter strainer in the side of the unit.
3. Open the supply valve and flush the tubing into a bucket or building drain for about 30 seconds.
4. After the water line is purged, close the valve and reconnect the supply line to the inlet strainer/flow regulator.

### **3.2 Initial Operation Checklist**

For new installations, ensure the unit is ready to operate by going through the following checklist prior to start-up:

1. The humidifier is installed horizontally and level.
2. No obstacle is within 15 feet in front of the atomizing direction.
3. The electrical wiring is correctly connected.
4. De-ionized or reverse osmosis water supply is used.
5. The water supply piping and overflow piping are correctly connected and secured.
6. All parts are correctly installed.

After the above items are checked, operation may begin.

### **3.3 Procedure for Operation**

1. Turn the main power source switch on the control box to the "On" position.
2. Open the water supply valve allowing water to flow to the humidifier.
3. Perform a manual drain cycle to flush any particulates from the tank utilizing the system controller (see STULZ Ultra-Series controller IOM manual #OUU0078, Section 5.5.1.2).
4. Set the humidity setpoint to the desired humidity level.
5. When power is supplied to the humidifier and there is a demand for humidification, water flows into the unit. When the water in the tank reaches the required level, the ultrasonic nebulizers will start producing mist.
6. If the unit does not start operating, increase the humidity setpoint to create a demand for humidification.
7. During operation, the humidifier starts and stops by means of a signal from the control box.
8. The water level in the water tank is maintained by the level controller.
9. If the water level in the tank falls below the safety level for any reason during operation, power to the ultrasonic nebulizers is cut off by the level controller.

After operation is started, check the following items on a regular basis:

Atomized mist is visible through all the mist blow tubes.

Check the humidifier parts, overflow pipe and other piping for signs of leaking water.

Change the humidity setpoint to ensure the control box is interconnected properly and that it controls the operation of the humidifier.

Check to see that the mist diffusion is good and that objects in the room or any obstacle are not directly exposed to the mist.

## **3.4 Precautions**

Do not remove the air filter at the bottom of the humidifier during operation.

Do not block the outlet of the mist blow tubes; component failure could occur.

Drain the water from the water tank for sanitary reasons if the unit is turned off for more than 3 days.

## **3.5 Steps for Long Term Shutdown**

If the humidifier is not signalled to turn "On" for a period of three days, the level control board will automatically signal the humidifier to operate a drain cycle.

When operation is stopped for a long time (one week or longer), the following steps may be performed. Also, refer to Section 4.1, "Periodic General Maintenance".

Close the water supply valve.

Drain the water tank.

Turn the main switch on the control box to "Off".

Check and clean the water tank interior and the air filter.

To restart operation after a long-term shutdown, see the previous Section 3-3, "Procedure for Operation".

## 4.0 MAINTENANCE/REPAIRS

### 4.1 Periodic General Maintenance

Systematic, preventive maintenance of the humidifier is recommended for optimum system performance. Routine periodic maintenance should include, but is not limited to the following:

- Tightening electrical connections.
- Cleaning, inspecting the unit's components visually.
- Checking the level of water and ensuring no leaks are present.

A system should be established to record any problems, defects or deficiencies noted by operators and discovered during maintenance inspections, together with the actions taken. For assistance, contact STULZ Product Support (see Section 5.0). Ensure adherence to all safety precautions while performing any type of maintenance.

#### 4.1.1 General

Before the maintenance inspection and repairs are done, be sure to set the control box power switch to "Off" and close the water supply valve.

### **WARNING**

Turn off power to the unit unless you are performing tests that require power. With power and controls energized, the unit could begin operating automatically at any time.

Solid scaffolding must be provided for working in high places.

Care must be taken avoid injury by sharp edges of the sheet metal, etc.

### **CAUTION**

The transducer is a very delicate part. When the water tank interior is cleaned, special care must be taken to ensure the transducer is not scratched on the surface with a screwdriver, etc.

Do not supply power to the ultrasonic nebulizer units while the transducer lead wires (yellow and orange) are removed.

Proper tools must be used. Excessive tightening or insufficient tightening may cause failure.

When performing maintenance or repairs, care must be taken to ensure small parts such as screws will not be lost.

Testing insulation resistance and dielectric withstand voltage should be avoided because the humidifier incorporates sensitive electronic parts.

When parts are replaced, genuine STULZ parts must be used. Contact STULZ Product Support for assistance.



**4.2 Maintenance Items and Necessary Tools**

<b>Item</b>	<b>Cycle</b>	<b>Description</b>	<b>Necessary Tools</b>
<b>Routine Maintenance</b>			
Air filter cleaning.	About once a week depending on the extent of contamination. The interval should be shortened if environmental conditions are particularly dusty.	Sect. 4.2.1	Phillips screwdriver
Visually inspect water supply strainer/flow regulator.	Inspect/clean every 3 months. Replace as necessary.	Sect. 4.2.2	
Check water tank interior, mist blow tubes and electrical parts.	Once a month or as required if environment is dusty or water supply quality is poor.	Sect. 4.2.3	
<b>Replacing Parts</b>			
Replacing temperature sensor.	If damaged or upon failure.	Sect. 4.4.3	Adjustable wrenches (2)
Replacing transducer.	After about 10,000 to 15,000 hours of operation.	Sect. 4.4.4	Phillips screwdriver 5.5 mm Nut driver
Replacing nebulizer print plate.	If damaged or upon failure. Also recommended when replacing transducer.	Sect. 4.4.5	Soft cleaning cloth Small brush
Replacing water supply solenoid valve.	If damaged or upon failure.	Sect. 4.4.6	Diagonal wire cutter
Replacing float switches.			
Replacing printed circuit board.			

## 4.2.1 Air Filter

- 1) Stop the humidifier.
- 2) Loosen and remove the filter case mounting screws (2 Pcs.) at the lower front of the humidifier. [Photo 1](#)
- 3) Pull out the filter case. [Photo 2](#)
- 4) Wash the filter media with clean water.
- 5) Lightly shake off excess water and dry it well in the shade.
- 6) When the filter is dried, put it back in the filter case, install the stopper and install the filter case in the humidifier.
- 7) If the filter is seriously clogged and cannot be cleaned by washing with water, or if it is seriously deteriorated, it should be replaced with a new one.



## 4.2.2 Water Supply Strainer/Flow Regulator

- 1) Stop the humidifier, set the control box disconnect switch to "Off" and close the water supply valve.
- 2) Remove the water supply tubing from the 90° inlet fitting. [Photo 3](#)
- 3) Loosen the strainer/flow regulator assembly and remove it.
- 4) Inspect the inlet screen and clean with DI water to remove any debris.
- 5) Re-install the strainer/flow regulator and water supply tubing.

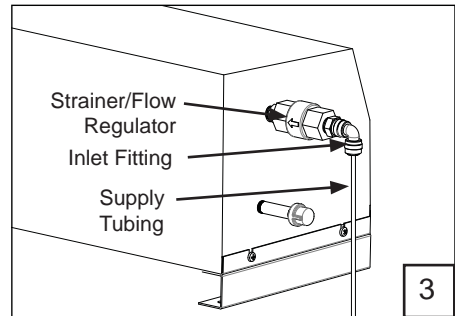

## 4.2.3 Electrical Parts

- 1) Stop the humidifier, set the control box disconnect switch to "Off" and close the water supply valve.
- 2) Drain the water tank.

### **Note**

Be careful not to splash water onto the electrical parts.

- 3) Remove the mist guide cover from the top of the humidifier.
- 4) Remove the screws (4 Pcs.) holding the electrical box access cover. [Photo 4](#)
- 5) Remove the electrical box access cover. [Photo 5](#)

Inspect the interior and check the following:

- No water leakage from the solenoid valve joint.
- No damage to electrical wires or cables.
- No abnormality of parts.



6) Remove the terminal connectors (3 Ea.) from the sides of the level control board. [Photo 6](#)

7) Slide the board out and ensure there is no discoloration, deformation or deterioration of the printed circuit. [Photo 7](#)

If any defects are found with the electrical parts, take necessary steps referring to Sect. 4.4 "Common Repairs/Parts Replacement".



#### 4.2.4 Float Switches

1) Loosen and remove the float panel mounting screws (2 Pcs.) [Photo 8](#)

##### **Note**

Don't let the screws drop into the tank.

2) Lift the float panel out and turn it over. [Photo 9](#)

3) Check for contamination. Manually operate the two float switches ensuring they raise and lower smoothly. Clean any build-up from the two float switches with a small brush.

[Photo 10](#)

##### **Note**

Be careful not to remove the float portion from the stem.

4) If no defects are found through the above inspection, re-assemble by reversing the above procedure.

##### **Note**

When assembling, be careful not to pinch the wires between the sheet metal.

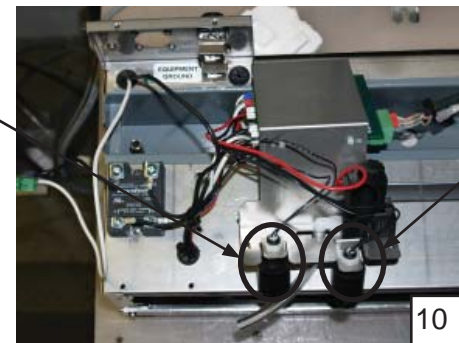
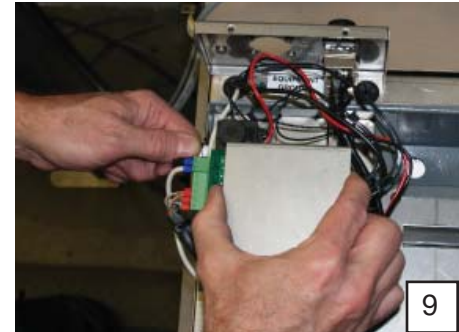
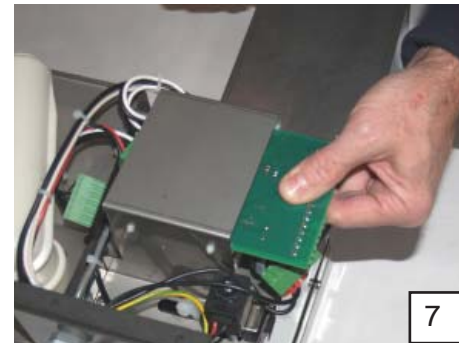

**4.2.5 Water Tank**

1) Loosen the fan casing mounting screws (4 Pcs.) on the sides of the humidifier and slide it up from the base. Photo 11

2) Turn the fan casing on it's side. Remove the screw inside the casing (1 Pcs.) holding the air flow guide (water tank cover). Photo 12

3) Return the fan casing to an upright position and remove the screws (2 Pcs.) holding the airflow guide on top of the humidifier. Remove the air flow guide. Photo 13

4) Check the water tank interior for contamination. Wipe and clean the water tank interior and clean the surface of the transducers, etc. in the water tank by wiping with a soft, oil free cleaning cloth. Photo 14

**Note**

Be careful not to scratch the surface of the transducers.



11



12



13



14

**4.2.6 Mist Guides**

1) Rotate and remove the mist guide tubes from the air flow guide (water tank cover). Photo 15 & 16

2) Clean the mist blow tubes with clean water.

**Note**

It is essential that the mist outlet and its surrounding area are free from foreign material.

**Note**

Be careful not to damage the rubber ring portion of the mist outlet.

3) Re-assemble by reversing the above procedure.



15

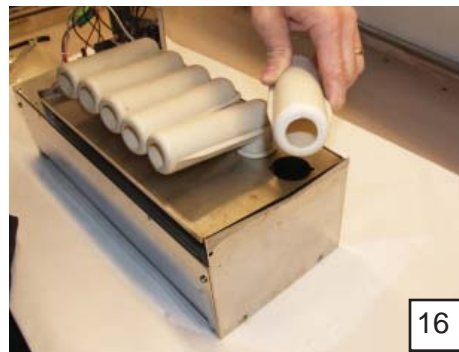

16

**4.3 Troubleshooting and Repair**

Should any failure occur, make the necessary repairs referring to the following tables. As a rule, power must be turned off when troubleshooting is performed but if it is absolutely necessary to troubleshoot when power is supplied, special attention must be paid to avoid electric shock and short-circuiting.

**1) First the humidifier and its surrounding area should be checked.**

Failure	Cause		Checking	Remedy
No mist is generated.	Power supply system	Control box switch turned off.	Visually check switch position.	Turn switch on.
		No power to the power supply.	Measure the voltage at power supply input terminals.	Supply power.
		Faulty power supply	Measure the voltage at power supply output terminals.	Replace the power supply.
	Water supply system	Water supply valve is closed.	Check if the valve is opened or closed.	Open the valve
	Other	Temperature sensor detects overheating.	Check if ambient temperature and water temperature are within specified range.	Correct.
Amount of mist is too low.	Power supply system	Supply voltage is low.	Check voltage at power supply output terminals.	Correct the voltage with the adjustment screw on the power supply.
	Water supply control system	Operating water level is high and overflowing.	Visually check.	See table 3) on next page.
	Other	Humidifier is not level.	Visually check.	Correct.
		‡Air filter clogging.	Pull out the filter and visually check.	Clean the filter.
Mist supply is coarse.	Power supply system	Supply voltage is high.	Check voltage at power supply output terminals.	

**2) If the cause can not be located through the above checking, remove the mist guide cover and air flow guide and check the interior of the water tank.**

Failure	Cause	Checking	Remedy
No mist is generated.	‡ Dust and foreign material are accumulated in the water tank.	Visually check the interior of the water tank.	Clean the interior of the water tank.
Amount of mist is too low.	‡ Dust and foreign material are accumulated in the water tank.		Clean interior of water tank and replace the transducer.
	‡ Scale deposited on transducer surface.		

Remarks:

The causes of failures marked ‡ can be prevented through periodic maintenance/inspection. See Section 4.1, "Periodic General Maintenance".

**3) If the cause cannot be located through the above checking, parts may faulty. Check the interior of the humidifier.**

Failure	Cause		Checking	Remedy
No mist is generated.	Water supply control system	Water supply float switch (FS1) is faulty.	Drain the water tank, remove the printed circuit board terminal (X3) and test the continuity of the float switch.	If there is no continuity, replace the switch.
		‡ Water supply float switch sticking.		Clean the switch. If operation is not restored, replace switch.
		Water supply solenoid valve is faulty.	No water supply is provided even if the water tank is drained and voltage between terminals X2-1 & X2-2 on the printed circuit board is 24VDC.	Replace the solenoid valve.
		Float switch for low water level is faulty.	With the water tank filled with water, remove the wire from terminal (X3) on the printed wiring board and check continuity of float switch.	If there is no continuity, replace the switch.
		‡ Float switch for low water level is sticking.		Clean the switch. If operation is not restored, replace switch.
	Other	Fan lead wires are loose or disconnected from the terminals.	Open the electrical section and check the lead wire connecting terminals.	Correct terminations.
Amount of mist is too low.	Water supply system overflowing.	Water supply float switch is faulty.	If the water level in the tank is up to the overflow pipe, remove the wire from terminal (X3) on the printed circuit board and ensure there is no continuity on the float switch.	If there is continuity, replace the switch.
		‡ Water supply float switch arm sticking.		Clean the switch. If operation is not restored, replace switch.
		Water supply solenoid valve is faulty.	Overflowing occurs even after power is turned off.	Replace the solenoid valve.

**4) Consumable parts**

Failure	Cause	Checking	Remedy
No mist output, or mist output is too low.	Deterioration of transducer due to aging.	The life is about 10,000 to 15,000 hours of humidifier operation.	Replace the transducer.

Remarks:

If the humidifier is operated for a long time with a deteriorated transducer, the nebulizer print plate may fail. The transducers should be replaced using the estimated lifetime of 10,000 to 15,000 hours as the point of reference.

If the cause cannot be located through the above checking, please contact STULZ Product Support.

If the humidification system is supplied with a water conductivity sensor (optional), ensure the sensor is operating properly and that the supply water is within the recommended guidelines for mineral content.

## 4.4 Common Repairs/Parts Replacement

When parts are replaced, refer to sections “4.4.1 Preparation for Repairs” and “4.4.2 Re-assembling”.

### 4.4.1 Preparation for Repairs (Removal of Water Tank)

1) Stop the humidifier, set the power supply circuit breaker (main switch) to “Off” and close the water supply valve.

2) Drain the water tank.

3) Remove the air flow guide (water tank cover) mounting screws from the top of the humidifier and remove the air flow guide. [Photo 17](#)

4) Remove the water tank mounting screws from the humidifier fan casing. [Photo 18](#)

5) Lift the water tank from the base and place it on a well lit work surface for removing/replacing the parts. [Photo 19](#)

6) The transducers are visible when you rotate the tank to view the bottom. [Photo 20](#)

7) The nebulizer print plates are on the side of the tank adjacent to the transducers. [Photo 21](#)

### 4.4.2 Re-assembling

1) Before re-assembling the humidifier, confirm there is no water leakage by pouring water into the tank.

2) When re-assembling after replacing parts, inspect the interior and check the following points:

All the screws must be securely tightened.

All the lead wires must be correctly and securely connected. (Special attention should be paid to the fan lead wires.)

All the plates, boards and relays must be free from discoloration, deformation and deterioration.

Electrical wires must not be damaged.

3) After re-assembly is completed, supply water and power to the unit and turn it on. Check to see that normal nebulizing mist is visible from all the mist blow tubes and that there is no water leakage.



17

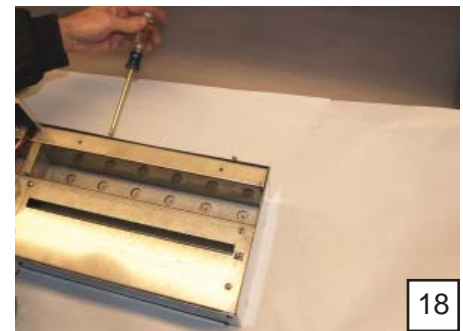

18



19



20



21

### 4.4.3 Replacing the Temperature Sensor

The temperature sensor is mounted to the front of the water tank. Referring to Section 4.4.1, "Preparation for Repairs" steps 1 - 5, place the water tank on a well lit work surface. Locate the sensor (see photo 22) and refer to section 4.4.3.1.

#### 4.4.3.2 Temperature Sensor on Water Tank

1) The temperature sensor is mounted on the front of the tank near the float switches. Carefully cut the wire tie holding the sensor cable and remove the nylon screw holding the sensor in place. Remove the sensor and save the mica pad and nylon screw to mount the new sensor. Photo 22

2) Remove the terminal connector from the sensor and connect it to the new sensor. Ensure the three slots in the terminal connector are oriented upwards. Photo 23

3) Install the new sensor to the tank together with the saved mica pad. Cable tie the sensor cable restrain it.

4) Referring to Sect. 4.4.2, "Re-assembling", re-assemble the unit by reversing the procedure described in Section 4.4.1.

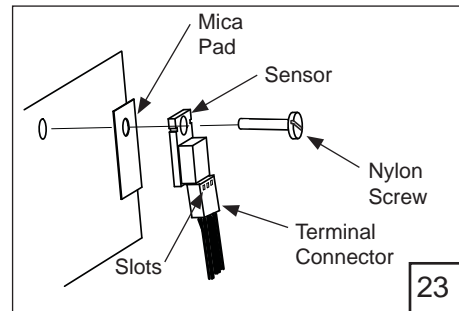



## 4.4.4 Replacing a Transducer

1) Referring to Section 4.4.1, "Preparation for Repairs", place the water tank on a well lit work surface.

2) To replace a transducer, remove the two transducer lead wires, (yellow and orange) from the nebulizer print plate.

[Photo 24](#)

### **Note**

Grasp the terminals when removing wires. Never pull the lead wires.

4) Using a 5.5 mm nut driver, remove the transducer mounting nuts (2 Pcs.) and remove the transducer, spacer and O-ring. Save the nuts to mount the new part.

[Photo 25](#)

5) Clean the spacer, O-ring groove and O-ring.

6) Assemble the new transducer with the spacer and O-ring and install them with the saved mounting screws. [Photo 26](#)

### **Notes**

Ensure the O-ring is not damaged. If it is damaged, replace it with a new one.

Carefully align the transducer's rubber packing in the indent in the bottom of the water tank to prevent leakage.

The mounting screws must be evenly tightened. Do not overtighten.

7) Connect the lead wires to the nebulizer print plate. The colored lead wires must be inserted as shown on the plate. (Orange wire to ORG, Yellow wire to YEL)

8) Referring to Sect. 4.4.2, "Re-assembling", re-assemble the unit by reversing the procedure described in Section 4.4.1.

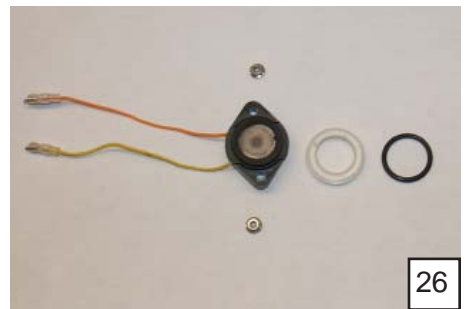
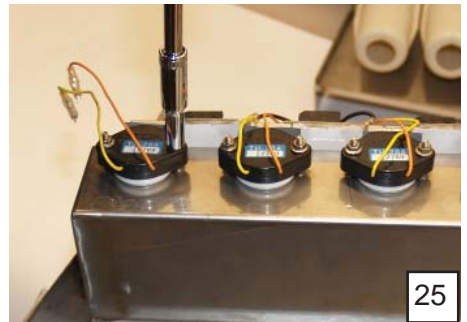
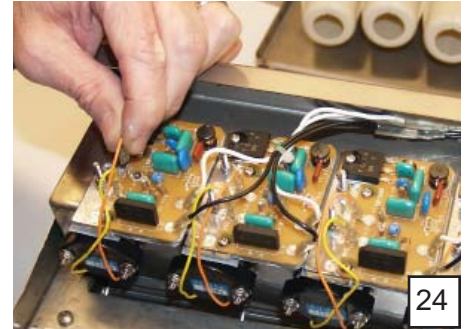

## 4.4.5 Replacing a Nebulizer Print Plate

1) Referring to Section 4.4.1, "Preparation for Repairs", place the water tank on a well lit work surface.

2) Using a 5.5 mm nut driver, remove the print plate mounting nuts (2 Pcs.) and remove the plate. Save the nuts and insulating parts to mount the new print plate. [Photo 27](#)

3) Remove the four wires connected to the terminals from the plate to be replaced. [Photo 28](#)

4) Install the new plate together with the silicon sheet provided using the saved mounting screws. [Photo 29](#)

5) Connect the nebulizer print plate interconnecting wires (black to H, white to G) and transducer lead wires (orange to ORG, yellow to YEL)

### **Note**

When the nebulizer print plate is replaced, it is recommended that the transducer be replaced also.

6) Referring to Sect. 4.4.2, "Re-assembling", re-assemble the unit by reversing the procedure described in Section 4.4.1.

## 4.4.6 Water Solenoid Valves, Float Switches and Level Control Board

1) Referring to Section "4.2.2, "Electrical Parts" and "4.2.3 Float Switches", remove the electrical access cover and lift the float panel out. [Photo 30](#)

2) Cut the band bundling the solenoid valve and float switch lead wires.

### **Note**

Be careful not to damage the lead wires.

3) Unscrew the connecting wires of the parts to be replaced from the terminal connectors on the level control board.

### 4.4.6.1 Fill Solenoid Valve

4) To replace the fill solenoid valve, remove the pipe fitting from the inlet side of the solenoid valve.

5) Turn the float panel over and remove the solenoid valve mounting screws (2 Pcs.). [Photo 31](#)

6) Remove the elbow on the outlet side and install the new solenoid valve on the outlet side. Be sure to seal the fitting with teflon tape.

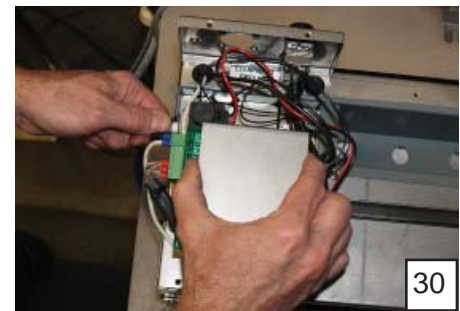
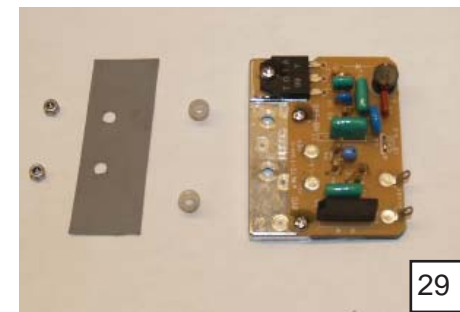
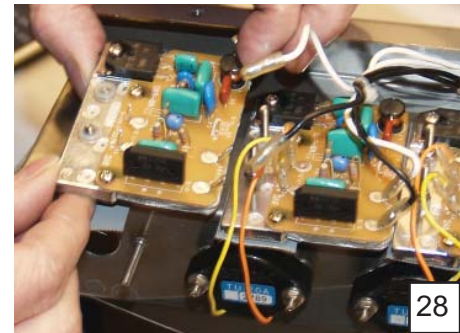
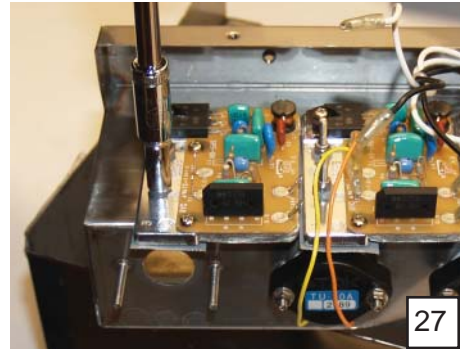

## **Note**

Ensure the elbow is facing the correct direction.

7) Install the new solenoid valve to the float panel and re-install the pipe fitting.

## **Note**

Ensure the O-ring is not damaged. If it is damaged, replace it with a new one.

### **4.4.6.2 Float Switch**

8) To replace a float switch, remove the lock nut on the float switch and replace the switch with a new one (ref. Photo 10).

### **4.4.6.3 Level Control Board**

9) To replace the level control board, remove the lead wire terminal connectors (3 Pcs.) from the board (see Photos 6 & 7).

## **Note**

Grasp the connectors when removing. Never pull the lead wires.

10) Slide the level control board out along the guides. Remove it and install a new one. [Photo 32](#)

### **4.4.6.4 Drain Solenoid Valve**

11) To replace the drain solenoid valve remove the humidifier fan casing as described in Section 4.2.5 and lay it on it's side. [Photo 33](#)

12) Using a 5.5 mm nut driver, remove the nuts holding the two valve outlet adapters. Unscrew the adapters from the solenoid valve and screw them into the replacement part. [Photo 34](#)

13) Referring to Section 4.4.2, "Re-assembling", assemble the unit by reversing the procedure described in Section 4.4.1.

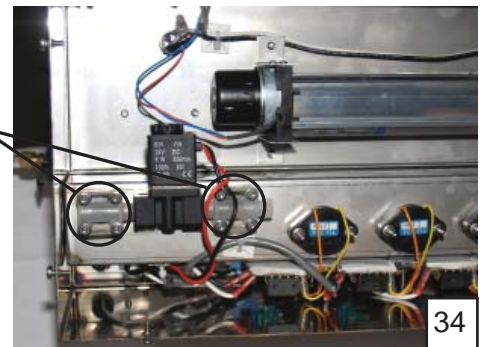
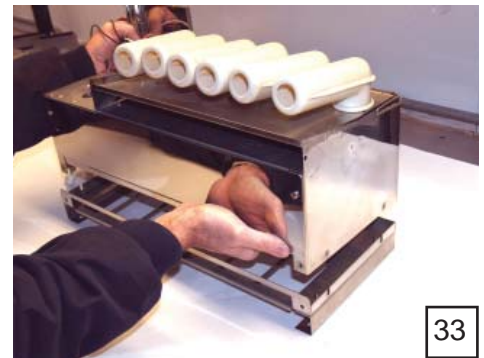

## **5.0 PRODUCT SUPPORT**

STULZ provides its customers with Product Support which not only provides technical support and parts but the following additional services, as requested:

- Performance Evaluations
- Start-up Assistance
- Training

STULZ recommends using the services of our Field Service Department to perform start-up and commissioning. They will ensure your equipment is correctly installed and operating properly. This will help ensure your unit provides years of trouble free service while operating at it's highest efficiency.

### **5.1 Technical Support**

The STULZ Technical Support Department is dedicated to the prompt reply and solution to any problem encountered with a unit. Should a problem develop that cannot be resolved using this manual, you may call (888) 529-1266 Monday through Friday from 8:00 a.m. to 5:00 p.m. EST. If a problem occurs after business hours, provide your name and telephone number. One of our service technicians will return your call.

When calling to obtain support, it is important to have the following information readily available, (information is found on the unit's nameplate):

- Unit Model Number (DRH-XX)
- STULZ Sales Order Number
- Unit Serial Number
- Description of Problem

### **5.2 Obtaining Warranty Parts**

Warranty inquiries are to be made through the Technical Support Department at (888) 529-1266 Monday through Friday from 8:00 a.m. to 5:00 p.m. EST. A service technician at STULZ will troubleshoot the system over the telephone with a field service technician to determine the defect of the part. If it is determined that the part may be defective a replacement part will be sent via UPS ground. If the customer requests that warranty part(s) be sent by any other method than UPS ground the customer is responsible for the shipping charges. If you do not have established credit with STULZ you must give a freight carrier account number.

A written (or faxed) purchase order is required on warranty parts and must be received prior to 12:00 p.m. for same day shipment. The purchase order must contain the following items:

- Purchase Order Number
- Date of Order
- STULZ Stated Part Price
- Customer Billing Address
- Shipping Address
- Customer's Telephone and Fax Numbers
- Contact Name
- Unit Model No., Serial No. & STULZ Item No.

The customer is responsible for the shipping cost incurred for returning the defective part(s) back to STULZ. Return of defective part(s) must be within 30 days at which time an evaluation of the part(s) is conducted and if the part is found to have a manufacturing defect a credit will be issued.

When returning defective part(s) complete the Return Material Authorization Tag and the address label received with the replacement part.

See the STULZ Standard Warranty located in section one of this manual.

### **5.3 Obtaining Spare/Replacement Parts**

Spare and replacement parts requests are to be made through Product Support by fax (301) 620-2606, telephone (240) 529-1266 or E-mail (parts@stulz-ats.com). Quotes are given for specified listed parts for a specific unit.

STULZ accepts Visa and MasterCard. STULZ may extend credit to its customers; a credit application must be prepared and approved (this process could take one week).

A 25% minimum restocking charge will be applied on returned stocked parts that were sold as spare/replacement parts. If the returned part is not a stocked item, a 50% restocking charge may be applied. Additionally a Return Material Authorization Number is required when returning parts. To receive credit for returned repair/replacement parts, the parts must be returned to STULZ within 30 days of the purchase date. Spare part sales over 30 days old will be considered final and the parts will remain the sole property of the ordering party.

**6.0 DRAWINGS**

**6.1 Layout Drawing of Humidifier (Covers Removed to Show Parts)**

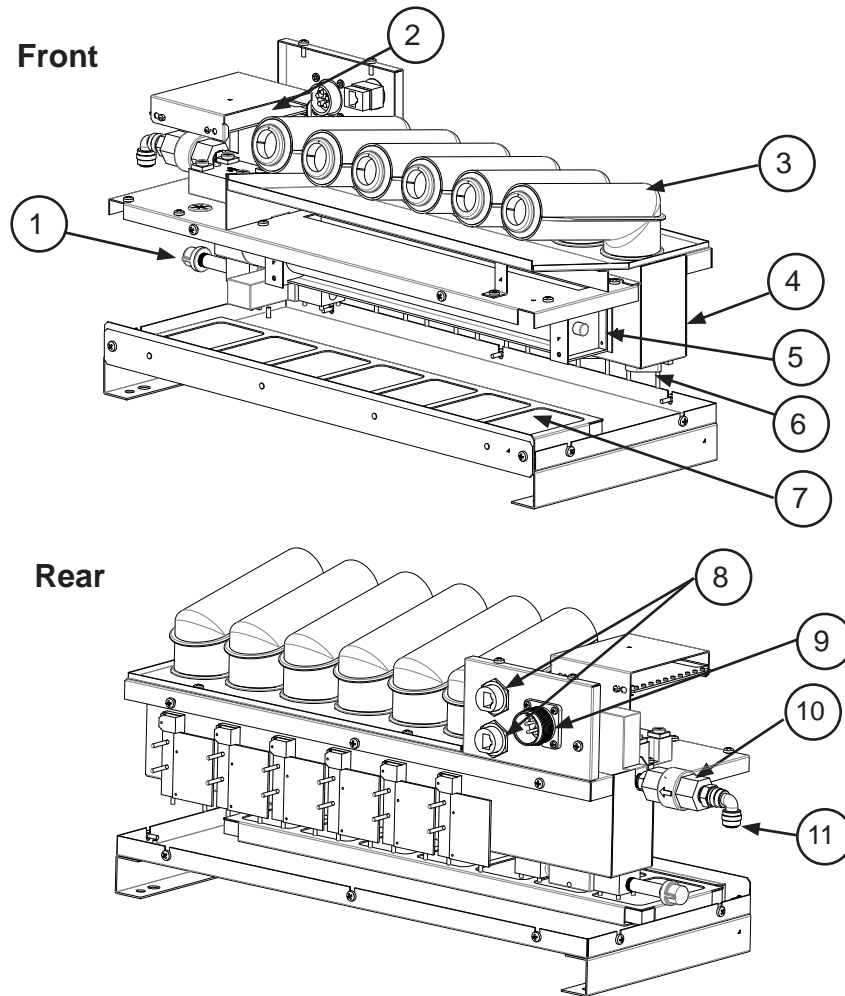

The bubble numbers called out in the drawings coincide with the item numbers listed below:

1	Drain Stub- 1/8" MPT With SS Cap
2	Level Control Board
3	Mist Guide Tube
4	Water Tank
5	Blower
6	Transducer
7	Filter
8	Data Communications Connections
9	Power Connection
10	Water Supply Strainer/flow regulator
11	Water Inlet Fitting

6.2 Electrical Circuit Diagrams

Typical Wiring Diagram for Modbus Version

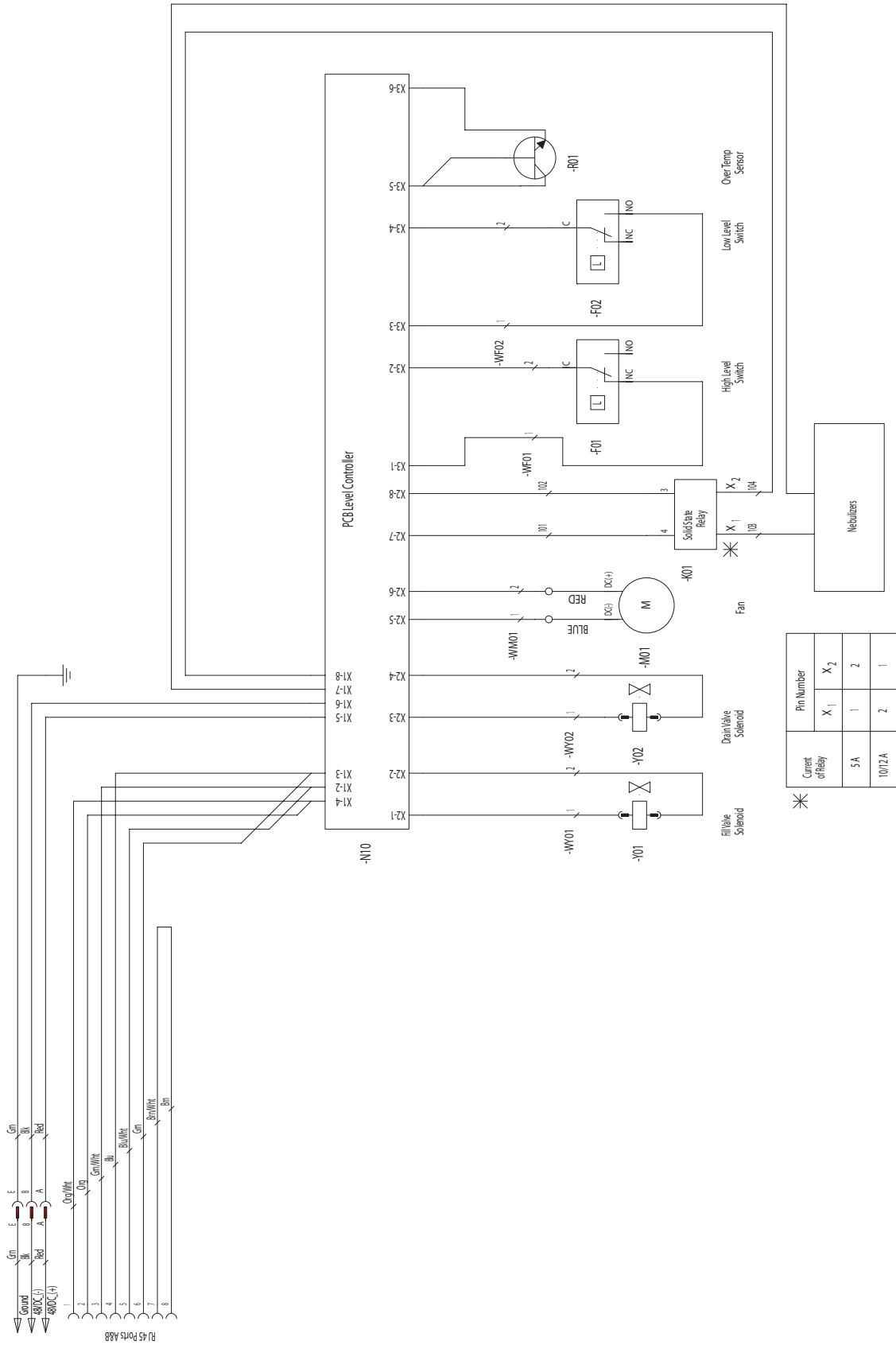

Typical Wiring Diagram for Stand-alone Version

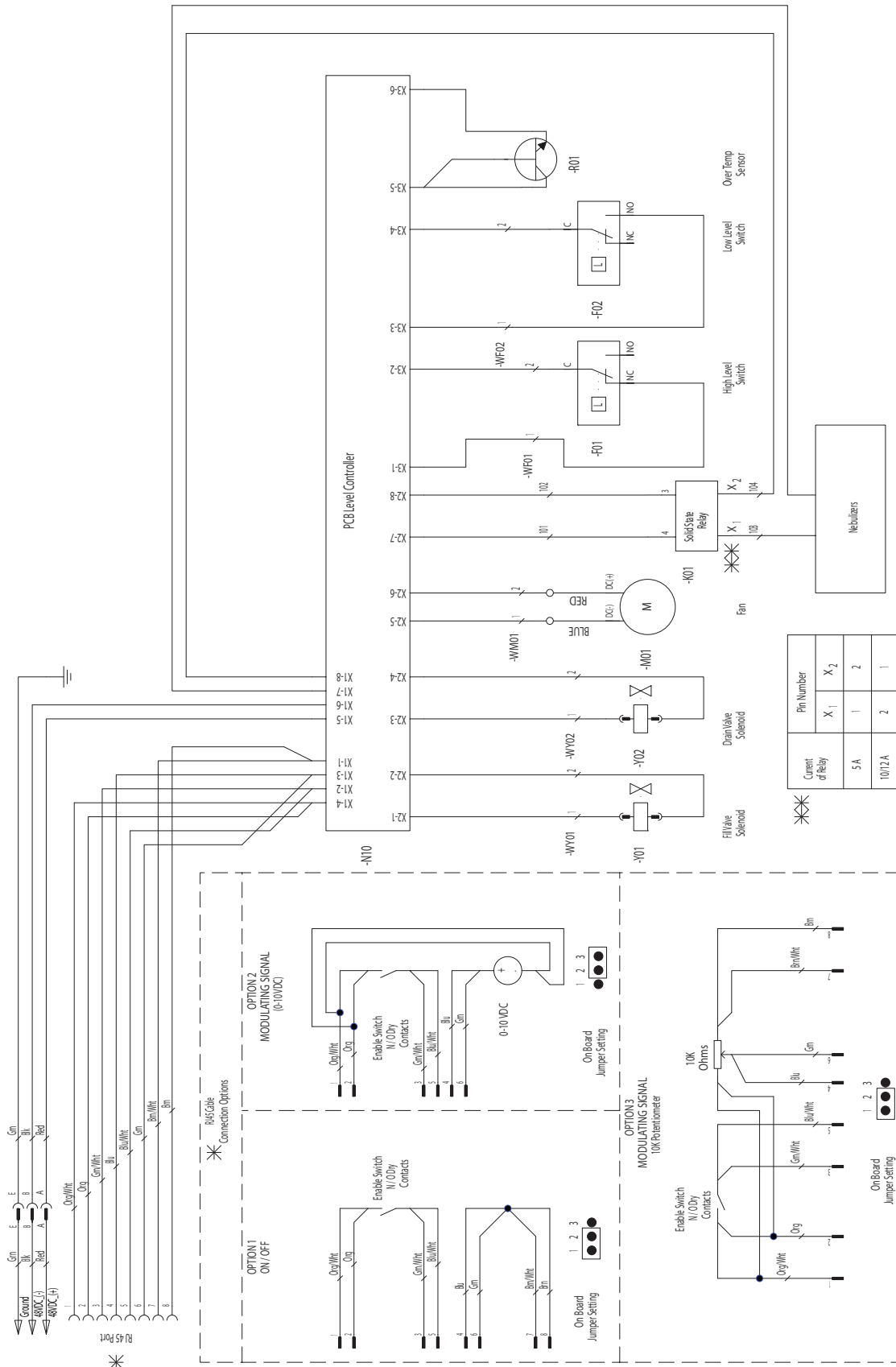

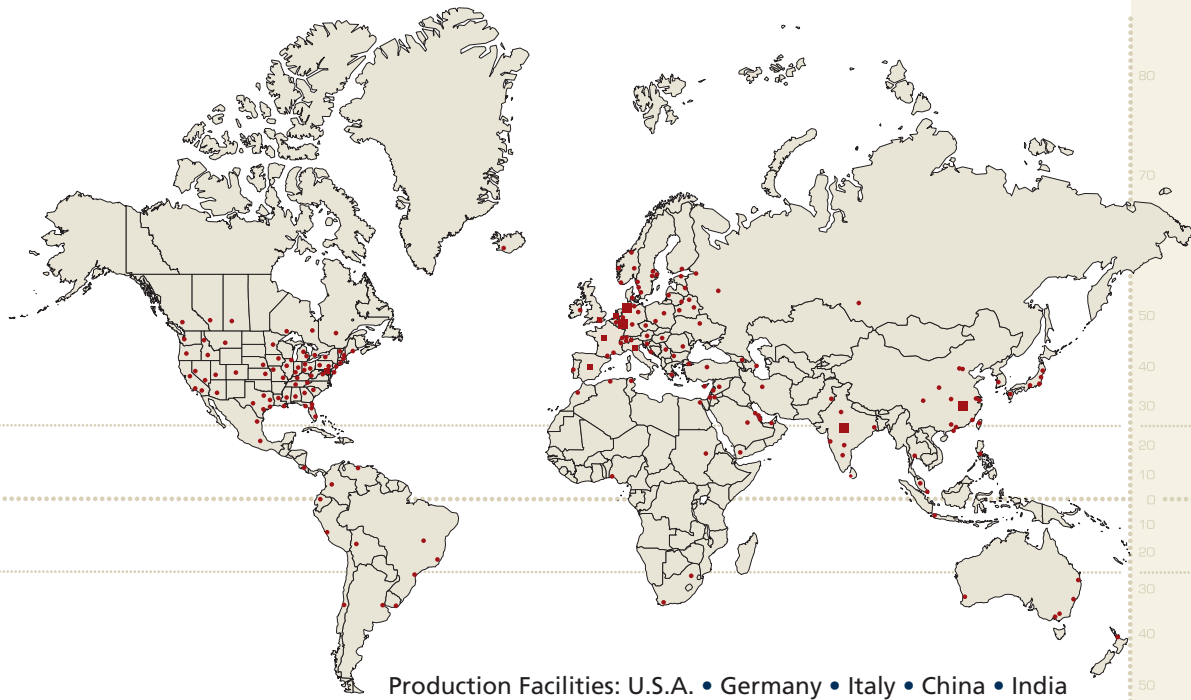

*STULZ mission is to be the premier provider of energy efficient temperature and humidity control solutions for mission critical applications.*

STULZ Air Technology Systems, Inc.  
 1572 Tilco Drive, Frederick, Maryland 21704  
 Phone: 301.620.2033, Fax: 301.662.5487  
 E-mail: [info@stulz-ats.com](mailto:info@stulz-ats.com)

[www.STULZ.com](http://www.STULZ.com)



ISO-9001 Quality Management System - Requirements

© March 2013  
 OUD0134-  
 Specifications subject to change without notice.